

**Media Carga**, almacenamiento para cargas voluminosas . Diseñado para carga manual en entornos industriales, comerciales y minoristas.

**Heavy-Duty Racking**, Storage for bulky loads. Designed for manual loading in industrial, commercial and retail settings.

**Charges Mi-lourd**, stockage pour charges volumineuses. Conçu pour le chargement manuel dans les environnements industriels, commerciaux et de vente au détail.

\*Altura libre de pandeo (distancia entre el suelo y el primer nivel)

\*Clearance height (distance from floor to first level)

\*Hauteur libre de flambage (distance entre le sol et le premier niveau)

h* (mm)	1000	1400	1800	2000
Kg**	5000	4800	3300	2600

\*\*Carga Admisible / Allowable load / Charge admissible



Longitud (mm)	L/900	L/1200	L/1500	L/1800	L/2100	L/2400
Length (mm)	1430 kg	1150 kg	900 kg	750 kg	575 kg	425 kg
Longueur (mm)						



**Bastidor** / Upright / Échelle



**Larguero** / Beam / Lisse



**Perno de seguridad**  
Safety pin  
Goupille de sécurité

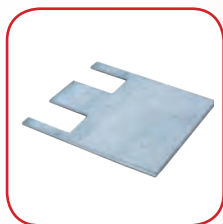

**Pletina**  
Levelling  
Plaque de calage



**Anclaje** / Anchor / Ancrage



**Travesaño aglomerado**  
Chipboard cross member  
Traverse bois



**Aglomerado**  
Chipboard  
Aggloméré



**Balda galvanizada**  
Galvanised shelf  
Tablette galvanisée



**Unión bifrontal**  
Bi-frontal attachment  
Union d'échelle



**Unión a pared**  
Attachment to wall  
Fixation au mur

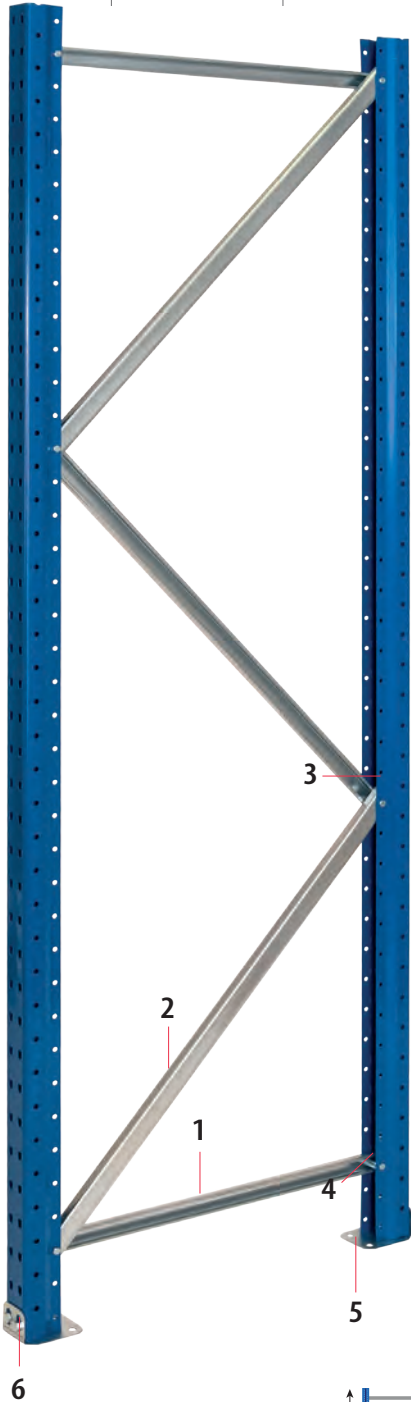
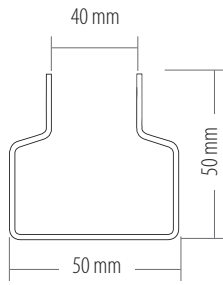

## Bastidor / Upright / Échelle

Artículo HxD Item HxD Article HxP	Referencia Reference Référence	€/ Unidad € / Unit €/ Unité	Cod. EAN EAN Code Code EAN	Peso kg Weight kg Poids kg	Uds. Paquete Units package Unités par paquet
2000 x 400	59032004	53,27	8431206590033	8,80	1
2000 x 500	59032005	54,36	8431206590149	9,00	1
2000 x 600	59032006	55,46	8431206590255	9,20	1
2000 x 800	59032008	58,23	8431206590361	9,60	1
2000 x 1000	59032010	61,07	8431206590477	10,00	1
2000 x 1200	59032012	62,52	8431206590583	10,50	1
2500 x 400	59032504	60,91	8431206590040	10,60	1
2500 x 500	59032505	61,95	8431206590156	10,80	1
2500 x 600	59032506	62,99	8431206590262	11,00	1
2500 x 800	59032508	65,96	8431206590378	11,40	1
2500 x 1000	59032510	69,67	8431206590484	11,90	1
2500 x 1200	59032512	70,94	8431206590590	12,40	1
3000 x 400	59033004	73,33	8431206590057	12,80	1
3000 x 500	59033005	74,75	8431206590163	13,00	1
3000 x 600	59033006	76,17	8431206590279	13,30	1
3000 x 800	59033008	80,11	8431206590385	13,80	1
3000 x 1000	59033010	83,07	8431206590491	14,30	1
3000 x 1200	59033012	84,48	8431206590606	14,90	1

RAL 5156 Azul / Blue / Bleu

Galvanizado / Galvanized / Galvanisée

## Componentes Bastidor / Upright components / Composants d'échelle

Altura Height Hauteur	Horizontales <sup>1</sup> Horizontal Horizontale	Diagonales <sup>2</sup> Diagonal Diagonale	Tornillo M6x40 <sup>3</sup> Screw M6x40 Vis M6x40	Casquillo <sup>4</sup> bushing douille	Pié Metálico <sup>5</sup> Metal foot Pied métallique	Tornillo M8x20 <sup>6</sup> Screw M8x20 Vis M8x20
1000	3	1	6	4	2	4
1500	2	2	5	2	2	4
2000	2	3	6	2	2	4
2500	3	3	8	4	2	4
3000	3	4	9	4	2	4

## Medidas de las Digonales y horizontales

Horizontal and diagonal measurements / Mesures horizontales et diagonales

	400	500	600	800	1000	1200
Profundidad / Depth / Profondeur	400	500	600	800	1000	1200
Horizontales / Horizontal / Horizontale	348	448	548	748	948	1148
Diagonales / Diagonal / Diagonale	713	765	825	968	1125	1303

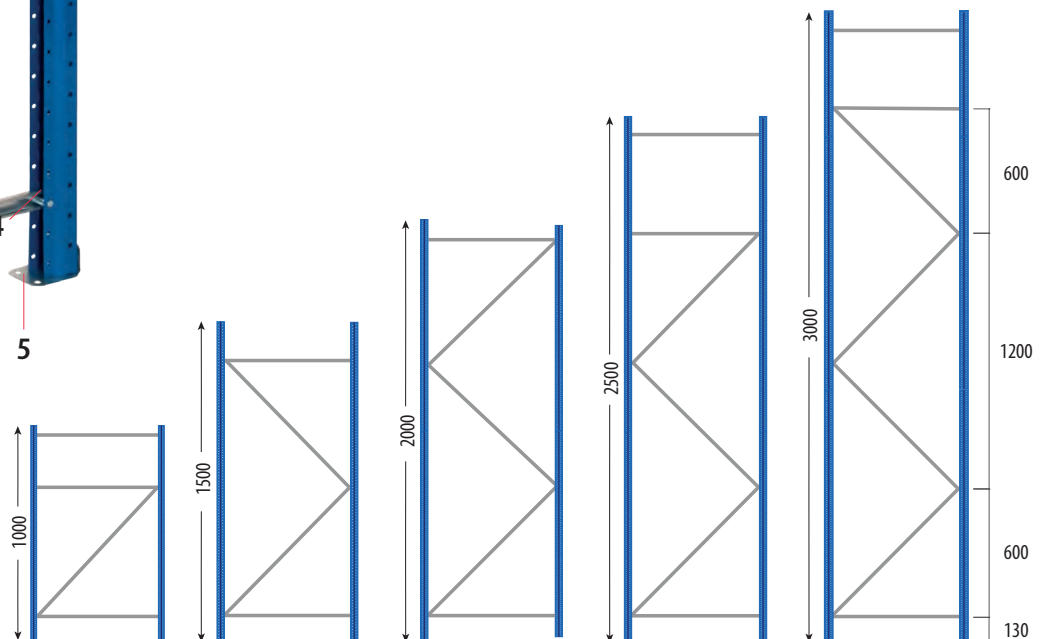

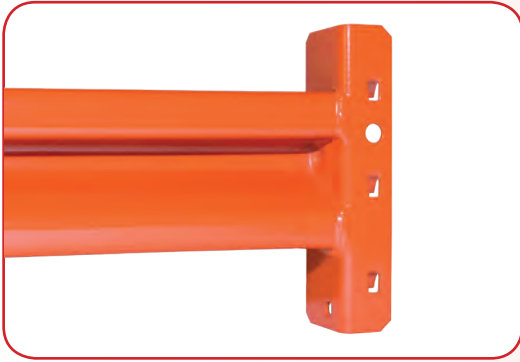

## Largueros / Beams / Lisses

Artículo L Item L Article L	Referencia Référence	€/ Unidad €/ Unité	Cod. EAN EAN Code Code EAN	Peso kg Weight kg Poids kg	Uds. Paquete Units package Unités paquet
Z80 x 30 / 900	59048409	15,15	8431206590677	2,00	2
Z80 x 30 / 1200	59048412	16,79	8431206590682	2,51	2
Z80 x 30 / 1500	59048415	17,79	8431206590699	3,02	2
Z80 x 30 / 1800	59048418	20,78	8431206590705	3,53	2
Z80 x 30 / 2100	59048421	23,19	8431206590712	4,04	2
Z80 x 30 / 2400	59048424	26,76	8431206590729	4,55	2

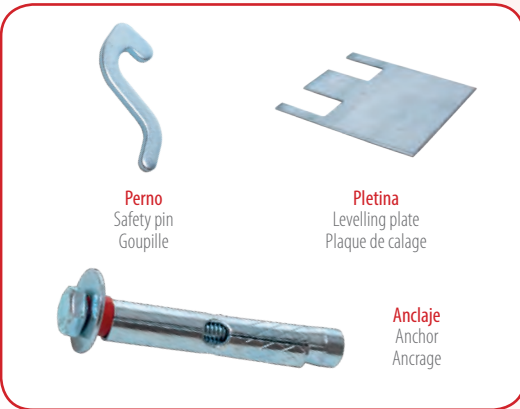
RAL 2154 Naranja / Orange / Orange 

## Accesorios / Accessories / Accessoires

Artículo Item Article	Referencia Référence	€/ Unidad €/ Unité	Cod. EAN EAN Code Code EAN	Peso kg Weight kg Poids kg	Uds. Paquete Units package Unités paquet
Perno de seguridad / Larguero Safety pin / Beam Goupille de sécurité / Lisse	59000001	0,20	8431206591016	0,01	2
Pletina de nivelación 1,5 mm Levelling plate 1,5 mm Plaques de calage 1,5 mm	59000008	1,00	8431206591023	0,05	2
M6 x 60/9 anclaje / Suelo M6 x 60/9 Anchor / Floor Ancrage M6 x 60/9 / Sol	59000034	0,48	8431206591030	0,02	2

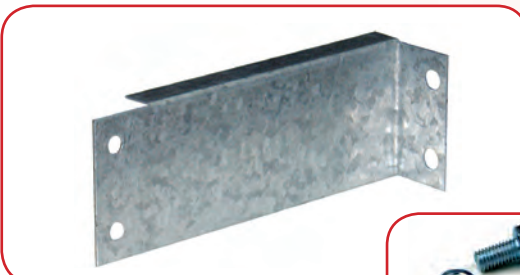
Galvanizado / Galvanized / Galvanisée 

Tornillería incluida / Screws included / Vis incluses

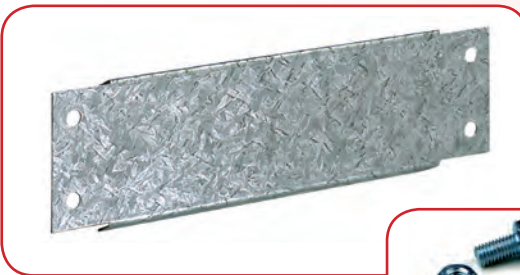

Tornillería incluida / Screws included / Vis incluses



## Uniones / Attachment / Unions

Artículo Item Article	Referencia Référence	€/ Unidad €/ Unité	Cod. EAN EAN Code Code EAN	Peso kg Weight kg Poids kg	Uds. Paquete Units package Unités paquet
Unión a pared 100 mm Attachment to wall 100 mm Fixation au mur 100 mm	59090036	3,83	8431206591047	0,24	1
Unión a pared 200 mm Attachment to wall 200 mm Fixation au mur 200 mm	59090038	4,13	8431206591061	0,38	1
Unión a pared 300 mm Attachment to wall 300 mm Fixation au mur 300 mm	59090040	4,43	8431206591085	0,52	1
Unión bifrontal 100 mm Bi-frontal attachment 100 mm Union bifrontale 100 mm	59090046	3,95	8431206591160	0,27	1
Unión bifrontal 200 mm Bi-frontal attachment 200 mm Union bifrontale 200 mm	59090047	4,25	8431206591177	0,41	1
Unión bifrontal 300 mm Bi-frontal attachment 300 mm Union bifrontale 300 mm	59090048	4,55	8431206591184	0,55	1

Galvanizado / Galvanized / Galvanisée 

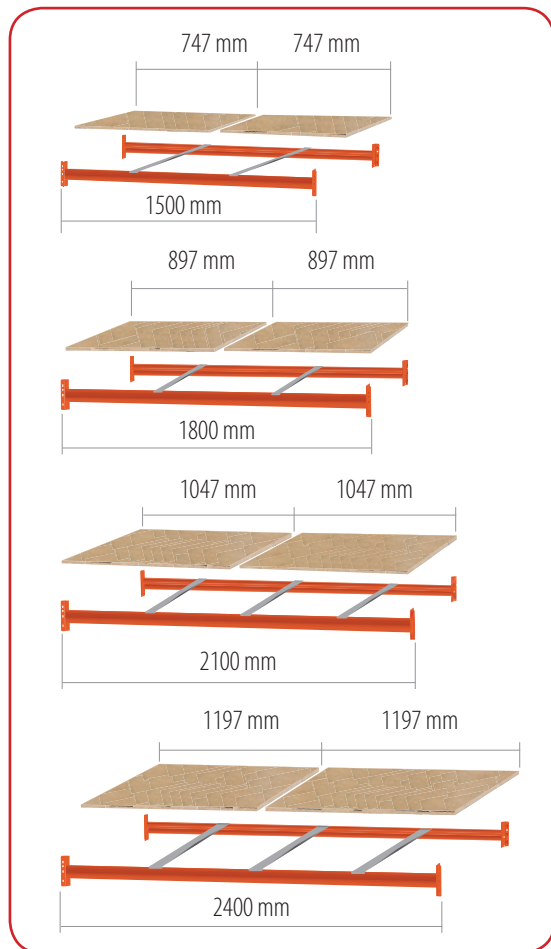
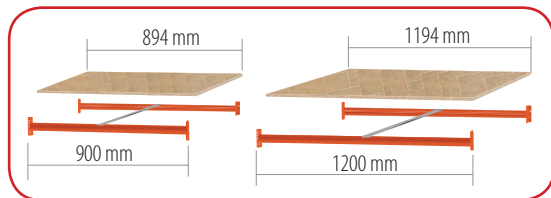
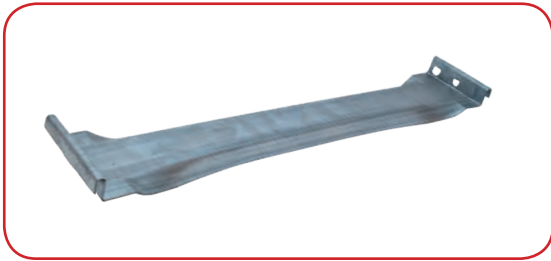

## Travesaños / Cross members / Traverses

Artículo L Item L Article L	Referencia Reference Référence	€/Unidad €/Unit €/Unité	Cod. EAN EAN Code Code EAN	Peso kg Weight kg Poids kg	Uds. Paquete Units package Unités paquet
400	59090055	5,59	8431206590835	0,40	1
500	59090056	6,22	8431206590842	0,48	1
600	59090057	6,85	8431206590859	0,56	1
800	59090058	8,11	8431206590866	0,72	1
1000	59090059	9,37	8431206590873	0,88	1
1200	59090060	10,63	8431206590880	1,04	1

Galvanizado / Galvanized / Galvanisée



## Aglomerado 1 pieza / Chipboard 1 item / Aggloméré 1 pièce

Para niveles con travesaño / For shelves with cross members / Pour étagères avec traverse

Artículo LxP Item LxD Article LxP	Referencia Reference Référence	€/Unidad €/Unit €/Unité	Cod. EAN EAN Code Code EAN	Peso kg Weight kg Poids kg	Uds. Paquete Units Package Unités par paquet
894 x 385	59089038	8,84	8431206596011	4,03	1
894 x 485	59089048	11,35	8431206596035	5,10	1
894 x 585	59089058	13,22	8431206596059	6,17	1
894 x 785	59089078	17,63	8431206596073	8,30	1
894 x 985	59089098	22,06	8431206596097	10,44	1
894 x 1185	59089118	26,47	8431206596110	12,57	1
1194 x 385	59119038	11,79	8431206596134	5,46	1
1194 x 485	59119048	14,69	8431206596158	6,88	1
1194 x 585	59119058	17,63	8431206596172	8,30	1
1194 x 785	59119078	23,53	8431206596196	11,15	1
1194 x 985	59119098	29,43	8431206596219	13,99	1
1194 x 1185	59119118	35,32	8431206596233	16,72	1

## Aglomerado 2 piezas / Chipboard 2 items / Aggloméré 2 pièces

Para niveles con travesaño /

Artículo LxP Item LxD Article LxP	Referencia Reference Référence	€/Unidad €/Unit €/Unité	Cod. EAN EAN Code Code EAN	Peso kg Weight kg Poids kg	Uds. Paquete Units Package Unités par paquet
747 + 747 x 385	59149038	15,17	8431206596257	6,88	1 + 1
747 + 747 x 485	59149048	18,98	8431206596271	8,54	1 + 1
747 + 747 x 585	59149058	22,41	8431206596295	10,32	1 + 1
747 + 747 x 785	59149078	30,38	8431206596318	13,88	1 + 1
747 + 747 x 985	59149098	37,96	8431206596332	17,43	1 + 1
747 + 747 x 1185	59149118	44,12	8431206596356	20,99	1 + 1
897 + 897 x 385	59179038	17,63	8431206596370	8,18	1 + 1
897 + 897 x 485	59179048	22,67	8431206596394	10,32	1 + 1
897 + 897 x 585	59179058	26,47	8431206596417	12,45	1 + 1
897 + 897 x 785	59179078	35,28	8431206596431	16,72	1 + 1
897 + 897 x 985	59179098	44,12	8431206596455	20,99	1 + 1
897 + 897 x 1185	59179118	52,91	8431206596479	25,26	1 + 1
1047 + 1047 x 385	59209038	21,71	8431206596493	9,61	1 + 1
1047 + 1047 x 485	59209048	25,31	8431206596516	12,10	1 + 1
1047 + 1047 x 585	59209058	30,38	8431206596530	14,47	1 + 1
1047 + 1047 x 785	59209078	40,47	8431206596554	19,45	1 + 1
1047 + 1047 x 985	59209098	50,61	8431206596578	24,43	1 + 1
1047 + 1047 x 1185	59209118	60,75	8431206596592	29,41	1 + 1
1197 + 1197 x 385	59239038	23,53	8431206596615	10,91	1 + 1
1197 + 1197 x 485	59239048	35,32	8431206596639	13,76	1 + 1
1197 + 1197 x 585	59239058	35,32	8431206596653	16,60	1 + 1
1197 + 1197 x 785	59239078	47,06	8431206596677	22,30	1 + 1
1197 + 1197 x 985	59239098	70,59	8431206596691	27,99	1 + 1
1197 + 1197 x 1185	59239118	70,59	8431206596714	33,68	1 + 1

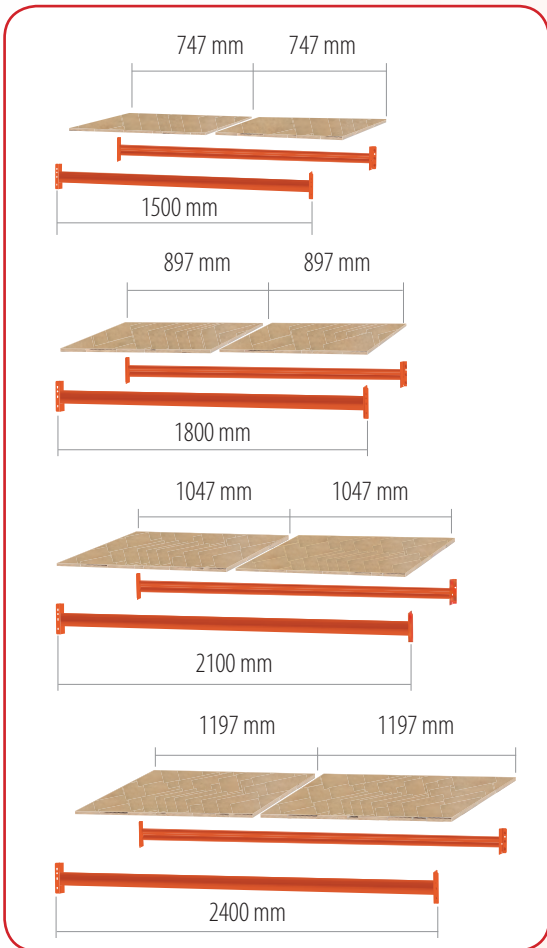
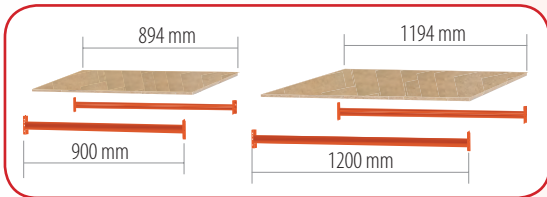
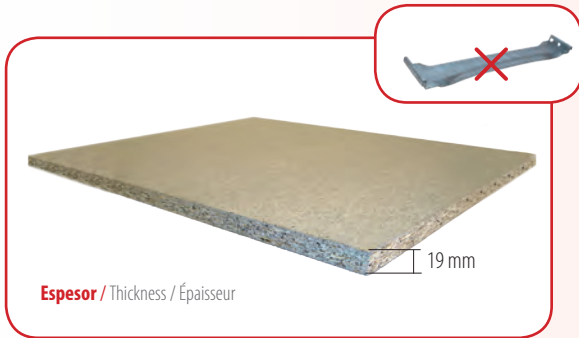

## Aglomerado 1 pieza / Chipboard 1 item / Aggloméré 1 pièce

Para niveles sin travesaño /

Artículo LxP Item LxD Article LxP	Referencia Reference Référence	€/Unidad €/Unit €/Unité	Cod. EAN EAN Code Code EAN	Peso kg Weight kg Poids kg	Uds. Paquete Units Package Unités par paquet
894 x 395	59089039	8,84	8431206596028	4,15	1
894 x 495	59089049	11,35	8431206596042	5,22	1
894 x 595	59089059	13,22	8431206596066	6,29	1
894 x 795	59089079	17,63	8431206596080	8,42	1
894 x 995	59089099	22,06	8431206596103	10,56	1
894 x 1195	59089119	26,47	8431206596127	12,69	1
1194 x 395	59119039	11,79	8431206596141	5,57	1
1194 x 495	59119049	14,69	8431206596165	7,00	1
1194 x 595	59119059	17,63	8431206596189	8,42	1
1194 x 795	59119079	23,53	8431206596202	11,27	1
1194 x 995	59119099	29,43	8431206596226	14,11	1
1194 x 1195	59119119	35,32	8431206596240	16,96	1

## Aglomerado 2 piezas / Chipboard 2 items / Aggloméré 2 pièces

Para niveles sin travesaño /

Artículo LxP Item LxD Article LxP	Referencia Reference Référence	€/Unidad €/Unit €/Unité	Cod. EAN EAN Code Code EAN	Peso kg Weight kg Poids kg	Uds. Paquete Units Package Unités par paquet
747 + 747 x 395	59149039	15,17	8431206596264	7,00	1 + 1
747 + 747 x 495	59149049	18,98	8431206596288	8,78	1 + 1
747 + 747 x 595	59149059	22,41	8431206596301	10,56	1 + 1
747 + 747 x 795	59149079	30,38	8431206596325	14,11	1 + 1
747 + 747 x 995	59149099	37,96	8431206596349	17,67	1 + 1
747 + 747 x 1195	59149119	44,12	8431206596363	21,23	1 + 1
897 + 897 x 395	59179039	17,63	8431206596387	8,42	1 + 1
897 + 897 x 495	59179049	22,67	8431206596400	10,56	1 + 1
897 + 897 x 595	59179059	26,47	8431206596424	12,69	1 + 1
897 + 897 x 795	59179079	35,28	8431206596448	16,96	1 + 1
897 + 897 x 995	59179099	44,12	8431206596462	21,23	1 + 1
897 + 897 x 1195	59179119	52,91	8431206596486	25,38	1 + 1
1047 + 1047 x 395	59209039	21,71	8431206596509	9,84	1 + 1
1047 + 1047 x 495	59209049	25,31	8431206596523	12,33	1 + 1
1047 + 1047 x 595	59209059	30,38	8431206596547	14,83	1 + 1
1047 + 1047 x 795	59209079	40,47	8431206596561	19,69	1 + 1
1047 + 1047 x 995	59209099	50,61	8431206596585	24,67	1 + 1
1047 + 1047 x 1195	59209119	60,75	8431206596608	29,65	1 + 1
1197 + 1197 x 395	59239039	23,53	8431206596622	11,27	1 + 1
1197 + 1197 x 495	59239049	35,32	8431206596646	14,11	1 + 1
1197 + 1197 x 595	59239059	35,32	8431206596660	16,84	1 + 1
1197 + 1197 x 795	59239079	47,06	8431206596684	22,53	1 + 1
1197 + 1197 x 995	59239099	70,59	8431206596707	28,23	1 + 1
1197 + 1197 x 1195	59239119	70,59	8431206596721	33,92	1 + 1

## Baldas / Shelves / Tablettes

Artículo L Item L Article L	Referencia Reference Référence	€/Unidad €/Unit €/Unité	Cod. EAN EAN Code Code EAN	Peso kg Weight kg Poids kg	Uds. Paquete Units package Unités paquet
400 x 300	59090403	6,44	8431206590958	0,67	10
500 x 300	59090503	7,31	8431206590965	0,84	10
600 x 300	59090603	8,18	8431206590972	1,01	10
800 x 300	59090803	9,94	8431206590989	1,35	10
1000 x 300	59091003	11,70	8431206590996	1,69	10
1200 x 300	59091203	13,46	8431206591009	2,03	10

Galvanizado / Galvanized / Galvanisée

