



Altura libre de pandeo
 (distancia entre el suelo y el primer nivel <200 mm)
 Clearance height
 (distance from floor to first level <200 mm)
 Hauteur libre de flambement
 (distance entre le sol et le premier niveau <200 mm)

(*) Carga admisible (cuatro perfiles)
con una distancia de 500 mm entre niveles
 (*) Allowable load (four uprights)
 with a distance of 500 mm between levels
 (*) Charge admissible (quatre montants)
 avec une distance de 500 mm entre les niveaux

Larguero Beam Longueron	L/900	L/1200	L/1500	L/1800	L/2100	L/2400
	500 kg	500 kg	500 kg	500 kg	350 kg	350 kg

Carga uniformemente distribuida
 Even distribution of load / Charge répartie uniformément

Perfil / Upright / Montant



Fondo "L"
"L" Cross beam / Lisse



Base sencilla 40
Single foot / Pied pastique



Larguero "C"
"C" Beam / Traverse C



Aglomerado
Chipboard
Aggloméré

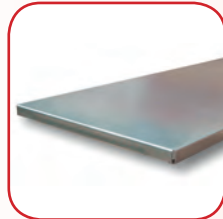

Travesaño de refuerzo
Deck support / Barre de renfort



Balda galvanizada
Galvanised shelf
Tablette galvanisée



Accesorios / accessories / accessoires

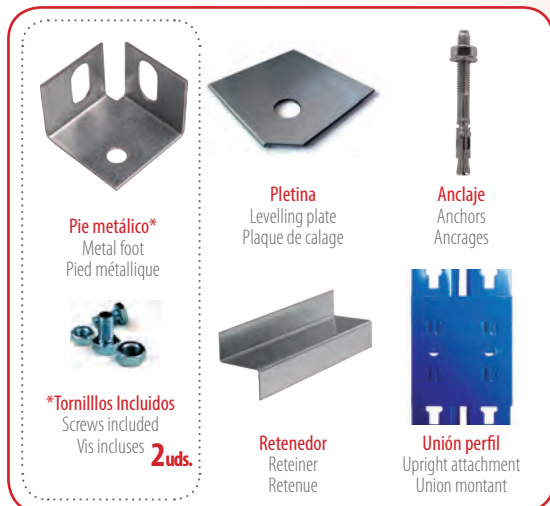

Artículo L Item L Article L	Referencia Reference Référence	€/Unidad €/Unit €/Unité	Código EAN EAN Code Code EAN	Peso k Weight k Poids k	Uds. Paquete Units Package Unités par paquet
Pletina 1,5 mm. 1.5 mm L. plate P. de calage 1,5 mm.	73000008	0,75	8431206730088	0,02	4
Pie Metálico Metal foot Pied métallique	73000031	1,30	8431206730316	0,04	4
Unión Perfil - Azul Bracket union - Blue Union Profilé - Bleu	73000033	1,00	8431206730330	0,09	4
Anclaje M6x60/suelo M6x60 Anchor/ floor Ancrage M6x60/sol	73000035	0,52	8431206730354	0,01	4
Retenedor GV. Retainer GV. Retenue GV.	75000006	0,87	8431206750062	0,03	2

J/40

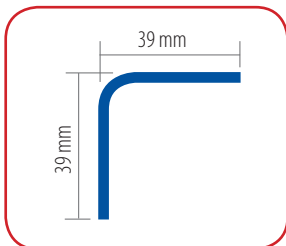
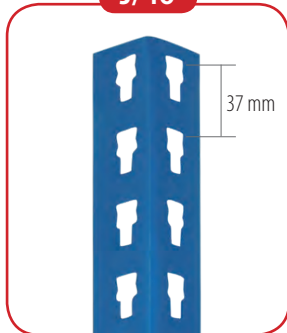

Perfiles / Uprights / Montants

Artículo L Item L Article L	Ref. Azul Ref. Blue Réf. Bleu	€/Unidad €/Unit €/Unité	Código EAN EAN Code Code EAN	Peso kg Weight kg Poids kg	Uds. Paquete Units Package Unités Paquet
J/40 de 1998	75034020	7,20	8431206751113	1,83	10
J/40 de 2479	75034025	8,93	8431206751137	2,27	10
J/40 de 2997	75034030	10,80	8431206751151	2,75	10

RAL 5010 Azul / Blue / Bleu

Fondos "L" / "L" Cross beams / Traverses "L"

Artículo L Item L Article L	Ref. Naranja Ref. Orange Réf. Orange	€/Unidad €/Unit €/Unité	Código EAN EAN Code Code EAN	Peso kg Weight kg Poids kg	Uds. Paquete Units Package Unités Paquet
L0300 / L	75041030	1,99	8431206751038	0,30	10
L0450 / L	75041045	2,98	8431206751045	0,45	10
L0600 / L	75041060	3,97	8431206751069	0,60	10
L0750 / L	75041075	4,96	8431206751083	0,75	10
L0900 / L	75041090	5,95	8431206751090	0,90	10
L1000 / L	75041100	6,61	8431206751106	1,00	10

RAL 2004 Naranja / Orange / Orange

Largueros "C" / "C" Beams / Lisses "C"

Artículo L Item L Article L	Ref. Naranja Ref. Orange Réf. Orange	€/Unidad €/Unit €/Unité	Código EAN EAN Code Code EAN	Peso kg Weight kg Poids kg	Uds. Paquete Units Package Unités Paquet
L0900 / C	75042090	7,36	8431206752097	1,15	10
L1200 / C	75042120	9,81	8431206752127	1,53	10
L1500 / C	75042150	12,26	8431206752158	1,91	10
L1800 / C	75042180	14,71	8431206752189	2,74	6
L2100 / C	75042210	17,16	8431206752219	3,20	6
L2400 / C	75042240	19,61	8431206752240	3,66	6

RAL 2004 Naranja / Orange / Orange

Travesaños de refuerzo / Deck supports / Barres de renforcement

Artículo L Item L Article L	Ref. Naranja Ref. Orange Réf. Orange	€/Unidad €/Unit €/Unité	Código EAN EAN Code Code EAN	Peso kg Weight kg Poids kg	Uds. Paquete Units Package Unités Paquet
L0450	75093045	3,00	8431206753049	0,44	10
L0600	75093060	3,68	8431206753063	0,57	10
L0750	75093075	4,36	8431206753087	0,70	10
L0900	75093090	5,04	8431206753094	0,83	10
L1000	75093100	5,49	8431206753100	0,92	10
L1200	75093120	6,40	8431206753124	1,09	10
L1500	75093150	7,76	8431206753155	1,35	10

Galvanizado / Galvanised / Galvanisée

Baldas / Shelves / Tablettes

Artículo LxP Item LxD Article LxP	Referencia Reference Référence	€/Unidad €/Unit €/Unité	Cod. EAN EAN Code Code EAN	Peso kg Weight kg Poids kg	Uds. Paquete Units Package Unités Paquet
300 x 300	75094030	5,56	8431206754039	0,75	10
450 x 300	75094045	6,87	8431206754046	1,04	10
600 x 300	75094060	8,18	8431206754060	1,33	10
750 x 300	75094075	9,49	8431206754084	1,62	10
900 x 300	75094090	10,80	8431206754091	1,91	10
1000 x 300	75094100	11,67	8431206754107	2,09	10

Galvanizado / Galvanised / Galvanisée

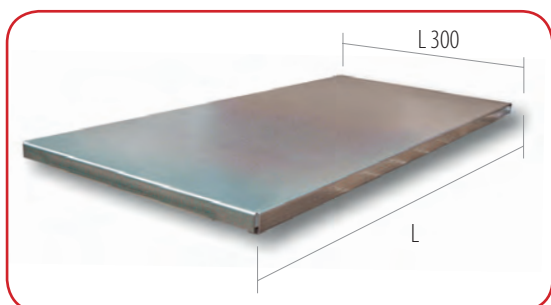
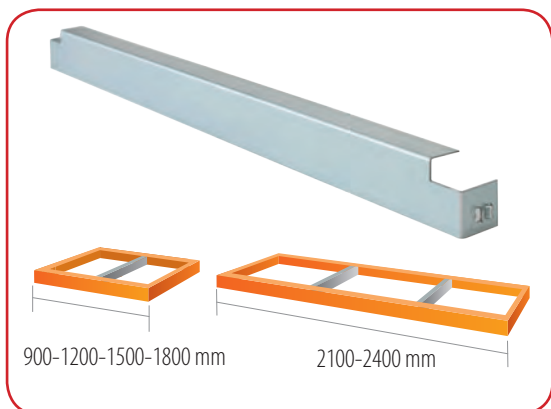

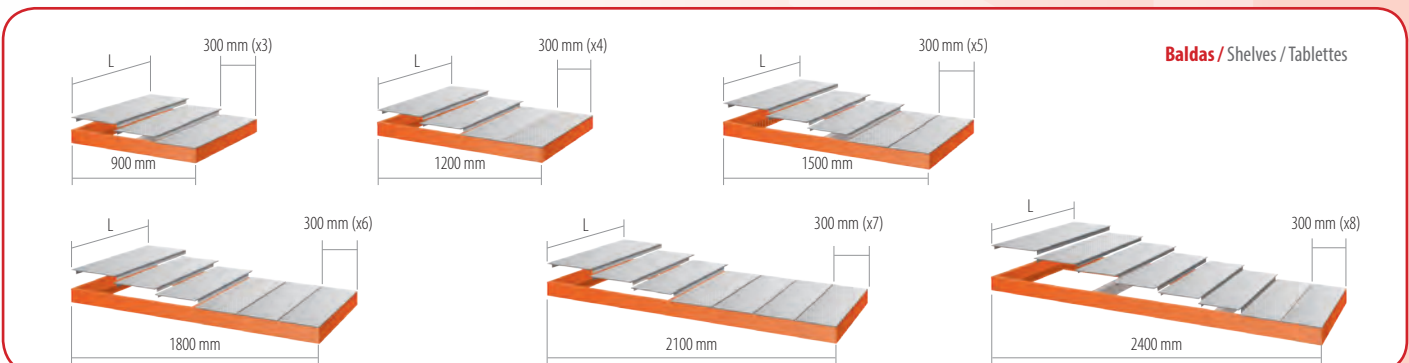
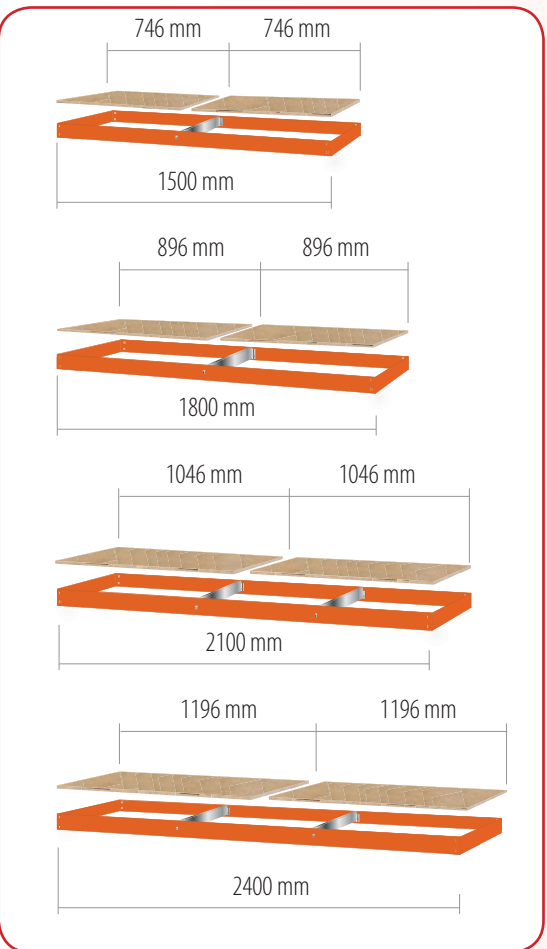
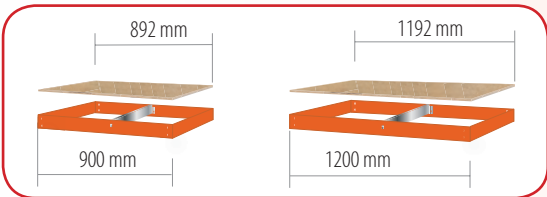
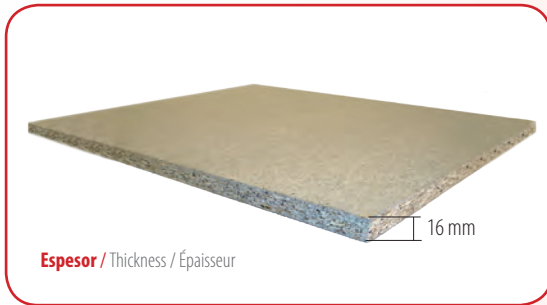

Aglomerado 1 pieza / Chipboard 1 item / Aggloméré 1 pièce

Artículo LxP Item LxD Article LxP	Referencia Reference Référence	€/Unidad €/Unit €/Unité	Cod. EAN EAN Code Code EAN	Peso kg Weight kg Poids kg	Uds. Paquete Units Package Unités par paquet
892 x 294	75090030	5,82	8431206750932	2,66	1
892 x 444	75090045	8,73	8431206750949	4,10	1
892 x 594	75090060	11,60	8431206750963	5,43	1
892 x 744	75090075	14,51	8431206750970	6,76	1
892 x 894	75090090	17,42	8431206750994	8,19	1
892 x 994	75090100	19,39	8431206750901	9,11	1
1192 x 294	75120030	7,75	8431206751236	3,58	1
1192 x 444	75120045	11,60	8431206751243	5,43	1
1192 x 594	75120060	15,51	8431206751267	7,27	1
1192 x 744	75120075	19,35	8431206751274	9,11	1
1192 x 894	75120090	23,26	8431206751298	10,96	1
1192 x 994	75120100	25,80	8431206751205	12,08	1

Aglomerado 2 piezas / Chipboard 2 items / Aggloméré 2 pièces

Artículo LxP Item LxD Article LxP	Referencia Reference Référence	€/Unidad €/Unit €/Unité	Cod. EAN EAN Code Code EAN	Peso kg Weight kg Poids kg	Uds. Paquete Units Package Unités par paquet
746 + 746 x 294	75150030	9,56	8431206751533	4,51	1 + 1
746 + 746 x 444	75150045	14,32	8431206751540	6,76	1 + 1
746 + 746 x 594	75150060	19,12	8431206751564	9,11	1 + 1
746 + 746 x 744	75150075	23,85	8431206751571	11,37	1 + 1
746 + 746 x 894	75150090	28,62	8431206751595	13,62	1 + 1
746 + 746 x 994	75150100	31,81	8431206751502	15,16	1 + 1
896 + 896 x 294	75180030	11,60	8431206751830	5,43	1 + 1
896 + 896 x 444	75180045	17,42	8431206751847	8,19	1 + 1
896 + 896 x 594	75180060	23,26	8431206751861	10,85	1 + 1
896 + 896 x 744	75180075	29,08	8431206751878	13,62	1 + 1
896 + 896 x 894	75180090	34,86	8431206751892	16,38	1 + 1
896 + 896 x 994	75180100	38,73	8431206751809	18,23	1 + 1
1046 + 1046 x 294	75210030	13,42	8431206752134	6,35	1 + 1
1046 + 1046 x 444	75210045	20,16	8431206752141	9,52	1 + 1
1046 + 1046 x 594	75210060	26,85	8431206752165	12,70	1 + 1
1046 + 1046 x 744	75210075	33,59	8431206752172	15,97	1 + 1
1046 + 1046 x 894	75210090	40,27	8431206752196	19,15	1 + 1
1046 + 1046 x 994	75210100	44,73	8431206752103	21,30	1 + 1
1196 + 1196 x 294	75240030	15,47	8431206752431	7,17	1 + 1
1196 + 1196 x 444	75240045	23,26	8431206752448	10,85	1 + 1
1196 + 1196 x 594	75240060	30,98	8431206752462	14,54	1 + 1
1196 + 1196 x 744	75240075	38,77	8431206752479	18,23	1 + 1
1196 + 1196 x 894	75240090	46,49	8431206752493	21,91	1 + 1
1196 + 1196 x 994	75240100	51,64	8431206752400	24,37	1 + 1

kits juegos completos / complete kits / Kits étagère

Aglomerado / Chipboard / Aggloméré

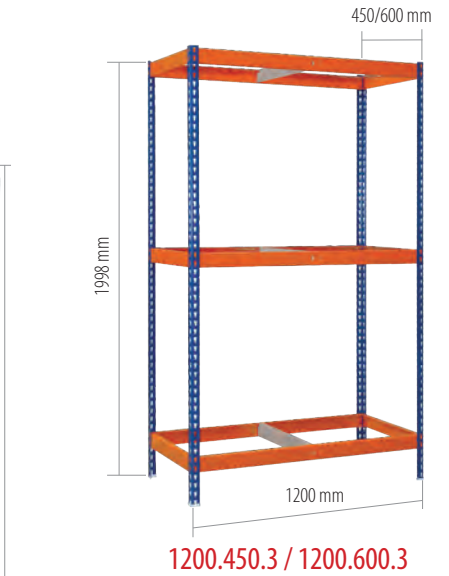

J 40

Carga admisible: 1750 kg*
Allowable load (kg)
Charge admissible (kg)



Sin tornillos
Without bolts
Sans vis



Martillo nylon
Nylon hammer
Marteau nylon



Tiempo de montaje
Assembly time
Temps de montage

Larguero Beam Longueron	L/1200	L/1500	L/1800
	500 kg	500 kg	500 kg

Instrucciones de montaje / Assembly instructions / Instructions d'assemblage

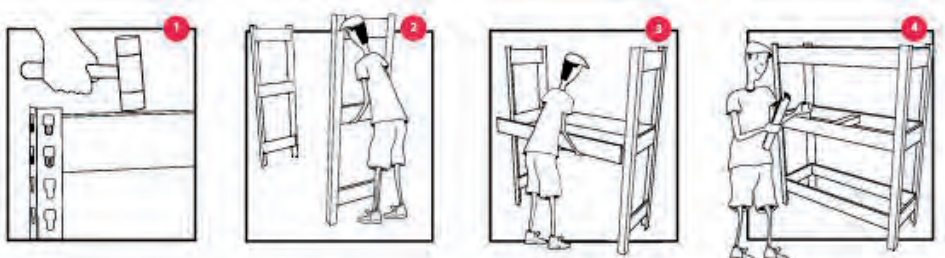

Unidades
Units / Unités

1200.450.3 / 1200.600.3



4
1998 mm



4
40 x 40 mm



6
450/600 mm



6
1200 mm

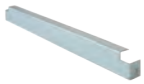

3
450/600 mm

J600 3 niveles / J600 3 levels / J600 3 niveaux

Artículo Item Article	Ref. Azul / Naranja Ref. Blue / Orange Réf. Bleu / Orange	€/Unidad €/Unit €/Unité	Cod. EAN EAN Code Code EAN	Peso kg Weight kg Poids kg	Uds. paquete Units package Unités par paquet	Dim. packaging Dim. packaging Dim. de l'emballage	Unidades palé Pallet units Unités par palettes
J600/1200.450.3	75031243	115,09	8431206752431	20,52	1	2000H x 120W x 80D	30
J600/1200.600.3	75031263	123,08	8431206752639	21,81	1	2000H x 120W x 80D	30

RAL 5010 Azul / Blue / Bleu RAL 2004 Naranja / Orange / Orange 

Aglomerado / Chipboard / Aggloméré

Artículo Item Article	Referencia Reference Référence	€/Envase €/Pack €/Emballage	Cod. EAN EAN Code Code EAN	Peso kg Weight kg Poids kg	Uds. envase Units pack Unités emballage	Dim. packaging Dim. packaging Dim. de l'emballage	Unidades palé Pallet units Unités par palettes
1192 x 444	75120453	34,80	8431206124535	16,29	3	1192W x 444D x 48H	30
1192 x 594	75120603	46,53	8431206126034	21,81	3	1192W x 594D x 48H	30

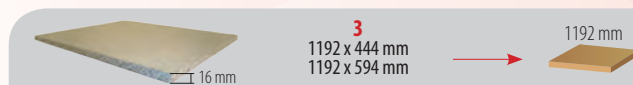

Unidades
Units / Unités

1500.450.3 / 1500.600.3



4
1998 mm



4
40 x 40 mm



6
450/600 mm



6
1500 mm



3
450/600 mm

J600 3 niveles / J600 3 levels / J600 3 niveaux

Artículo Item Article	Ref. Azul / Naranja Ref. Blue / Orange Réf. Bleu / Orange	€/Unidad €/Unit €/Unité	Cod. EAN EAN Code Code EAN	Peso kg Weight kg Poids kg	Uds. paquete Units package Unités par paquet	Dim. packaging Dim. packaging Dim. de l'emballage	Unidades palé Pallet units Unités par palettes
J600/1500.450.3	75031543	129,79	8431206755432	22,80	1	2000H x 120W x 80D	30
J600/1500.600.3	75031563	137,78	8431206755630	24,09	1	2000H x 120W x 80D	30

RAL 5010 Azul / Blue / Bleu RAL 2004 Naranja / Orange / Orange 

Aglomerado / Chipboard / Aggloméré

Artículo Item Article	Referencia Reference Référence	€/Envase €/Pack €/Emballage	Cod. EAN EAN Code Code EAN	Peso kg Weight kg Poids kg	Uds. envase Units pack Unités emballage	Dim. packaging Dim. packaging Dim. de l'emballage	Unidades palé Pallet units Unités par palettes
746 + 746 x 444	75075453	42,96	8431206154532	20,28	3 + 3	746W x 444D x 96H	30
746 + 746 x 594	75075603	57,33	8431206156031	27,33	3 + 3	746W x 594D x 96H	30



Unidades
Units / Unités

1800.450.3 / 1800.600.3



4
1998 mm



4
40 x 40 mm



6
450/600 mm



6
1800 mm



3
450/600 mm

J600 3 niveles / J600 3 levels / J600 3 niveaux

Artículo Item Article	Ref. Azul / Naranja Ref. Blue / Orange Réf. Bleu / Orange	€/Unidad €/Unit €/Unité	Cod. EAN EAN Code Code EAN	Peso kg Weight kg Poids kg	Uds. paquete Units package Unités par paquet	Dim. packaging Dim. packaging Dim. de l'emballage	Unidades palé Pallet units Unités par palettes
J600/1800.450.3	75031843	144,49	8431206758433	27,78	1	2000H x 120W x 80D	30
J600/1800.600.3	75031863	152,48	8431206758631	29,07	1	2000H x 120W x 80D	30

RAL 5010 Azul / Blue / Bleu RAL 2004 Naranja / Orange / Orange 

Aglomerado / Chipboard / Aggloméré

Artículo Item Article	Referencia Reference Référence	€/Envase €/Pack €/Emballage	Cod. EAN EAN Code Code EAN	Peso kg Weight kg Poids kg	Uds. envase Units pack Unités emballage	Dim. packaging Dim. packaging Dim. de l'emballage	Unidades palé Pallet units Unités par palettes
896 + 896 x 444	75090453	52,23	8431206184539	24,57	3 + 3	896W x 444D x 96H	30
896 + 896 x 594	75090603	69,78	8431206186038	32,55	3 + 3	896W x 594D x 96H	30



kits juegos completos / complete kits / Kits étagère

Aglomerado / Chipboard / Aggloméré



1200.450.4 / 1200.600.4



1500.450.4 / 1500.600.4



1800.450.4 / 1800.600.4

J 40

Carga admisible: 1750 kg*
Allowable load (kg)
Charge admissible (kg)



Sin tornillos
Without bolts
Sans vis



Martillo nylon
Nylon hammer
Marteau nylon



Tiempo de montaje
Assembly time
Temps de montage

Larguero	L/1200	L/1500	L/1800
Beam	500 kg	500 kg	500 kg
Longueron	500 kg	500 kg	500 kg

Instrucciones de montaje / Assembly instructions / Instructions d'assemblage

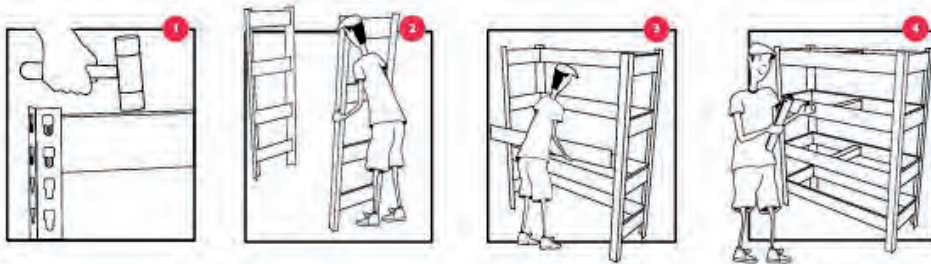

Unidades
Units / Unités

1200.450.4 / 1200.600.4



4
1998 mm



4
40 x 40 mm



8
450/600 mm



8
1200 mm

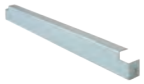

4
450/600 mm

J600 4 niveles / J600 4 levels / J600 4 niveaux

Artículo Item Article	Ref. Azul / Naranja Ref. Bleu / Orange Réf. Bleu / Orange	€/Unidad €/Unit €/Unité	Cod. EAN EAN Code Code EAN	Peso kg Weight kg Poids kg	Uds. paquete Units package Unités par paquet	Dim. packaging Dim. de l'emballage	Unidades palé Pallet units Unités par palettes
J600/1200.450.4	75031244	143,66	8431206752448	24,92	1	2000H x 145W x 80D	25
J600/1200.600.4	75031264	154,32	8431206752646	26,64	1	2000H x 145W x 80D	25

RAL 5010 Azul / Blue / Bleu RAL 2004 Naranja / Orange / Orange

Aglomerado / Chipboard / Aggloméré

Artículo Item Article	Referencia Reference Référence	€/Envase €/Pack €/Emballage	Cod. EAN EAN Code Code EAN	Peso kg Weight kg Poids kg	Uds. envase Units pack Unités emballage	Dim. packaging Dim. de l'emballage	Unidades palé Pallet units Unités par palettes
1192 x 444	75120454	46,40	8431206124542	21,72	4	1192W x 444D x 64H	25
1192 x 594	75120604	62,04	8431206126041	29,08	4	1192W x 594D x 64H	25

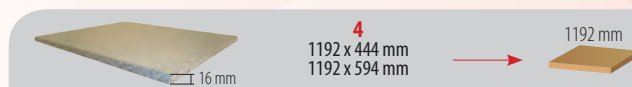

Unidades
Units / Unités

1500.450.4 / 1500.600.4



4
1998 mm



4
40 x 40 mm



8
450/600 mm



8
1500 mm



4
450/600 mm

J600 4 niveles / J600 4 levels / J600 4 niveaux

Artículo Item Article	Ref. Azul / Naranja Ref. Bleu / Orange Réf. Bleu / Orange	€/Unidad €/Unit €/Unité	Cod. EAN EAN Code Code EAN	Peso kg Weight kg Poids kg	Uds. paquete Units package Unités par paquet	Dim. packaging Dim. de l'emballage	Unidades palé Pallet units Unités par palettes
J600/1500.450.4	75031544	163,26	8431206755449	27,96	1	2000H x 145W x 80D	25
J600/1500.600.4	75031564	173,92	8431206755647	29,68	1	2000H x 145W x 80D	25

RAL 5010 Azul / Blue / Bleu RAL 2004 Naranja / Orange / Orange

Aglomerado / Chipboard / Aggloméré

Artículo Item Article	Referencia Reference Référence	€/Envase €/Pack €/Emballage	Cod. EAN EAN Code Code EAN	Peso kg Weight kg Poids kg	Uds. envase Units pack Unités emballage	Dim. packaging Dim. de l'emballage	Unidades palé Pallet units Unités par palettes
746 + 746 x 444	75075454	57,28	8431206154549	27,04	4 + 4	746W x 444D x 128H	25
746 + 746 x 594	75075604	76,44	8431206156048	36,44	4 + 4	746W x 594D x 128H	25



Unidades
Units / Unités

1800.450.4 / 1800.600.4



4
1998 mm



4
40 x 40 mm



8
450/600 mm



8
1800 mm



4
450/600 mm

J600 4 niveles / J600 4 levels / J600 4 niveaux

Artículo Item Article	Ref. Azul / Naranja Ref. Bleu / Orange Réf. Bleu / Orange	€/Unidad €/Unit €/Unité	Cod. EAN EAN Code Code EAN	Peso kg Weight kg Poids kg	Uds. paquete Units package Unités par paquet	Dim. packaging Dim. de l'emballage	Unidades palé Pallet units Unités par palettes
J600/1800.450.4	75031844	182,86	8431206758440	34,60	1	2000H x 145W x 80D	25
J600/1800.600.4	75031864	193,52	8431206758648	36,32	1	2000H x 145W x 80D	25

RAL 5010 Azul / Blue / Bleu RAL 2004 Naranja / Orange / Orange

Aglomerado / Chipboard / Aggloméré

Artículo Item Article	Referencia Reference Référence	€/Envase €/Pack €/Emballage	Cod. EAN EAN Code Code EAN	Peso kg Weight kg Poids kg	Uds. envase Units pack Unités emballage	Dim. packaging Dim. de l'emballage	Unidades palé Pallet units Unités par palettes
896 + 896 x 444	75090454	69,64	8431206184546	32,76	4 + 4	896W x 444D x 128H	25
896 + 896 x 594	75090604	93,04	8431206186045	43,40	4 + 4	896W x 594D x 128H	25



bancos de trabajo / work benches / bancs de travail

Artículo Item Article	Ref. Azul / Naranja Ref. Blue / Orange Réf. Bleu / Orange	€/ Unidad €/ Unit €/ Unité	Cod. EAN EAN Code Code EAN	Peso kg Weight kg Poids kg	Uds. paquete Units package Unités paquet	Dim. packaging Dim. packaging Dim. d'emballage	Unidades palé Pallet units Unités palettes
BTS / 900	75030091	87,49	8431206750093	21,64	1	900H x 600W x 70D	16
BTS / 1200	75030121	105,11	8431206750123	26,84	1	1200H x 600W x 70D	16
BTS / 1500	75030151	122,09	8431206750154	32,04	1	1500H x 600W x 70D	16

RAL 5010 Azul / Blue / Bleu RAL 2004 Naranja / Orange / Orange

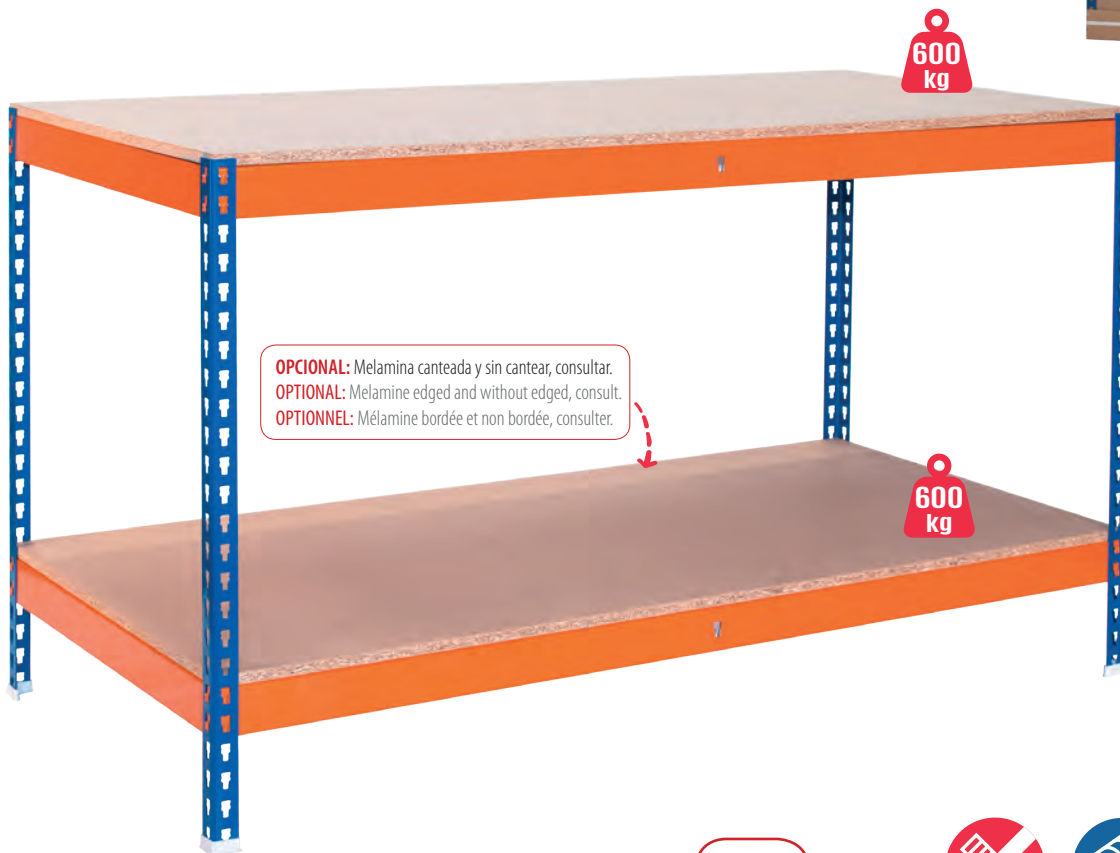

OPCIONAL: Melamina canteada y sin cantear, consultar.
OPTIONAL: Melamine edged and without edged, consult.
OPTIONNEL: Mèlamine bordée et non bordée, consulter.

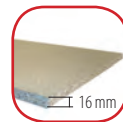

Sin tornillos
Without bolts
Sans vis



Martillo nylon
Nylon hammer
Marteau nylon







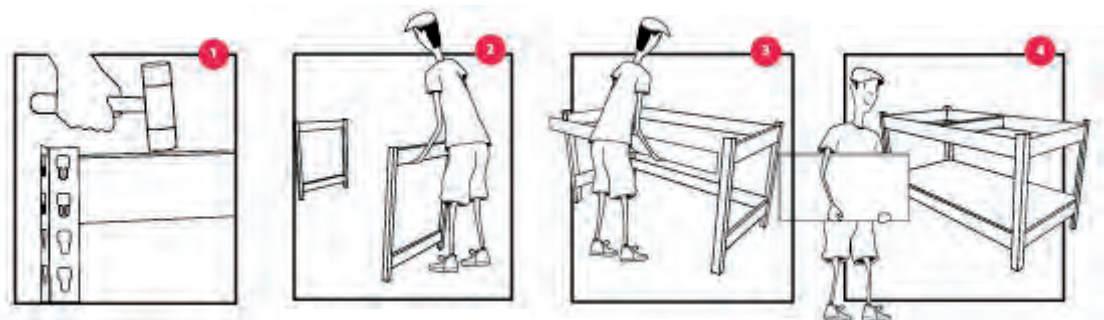

Tiempo de montaje
Assembly time
Temps d'assemblage

Instrucciones de montaje





Assembly instructions
Instructions d'assemblage



Unidades
Units / Unités
BTS / 900

	4 888 mm
	4 35 x 35 mm
	4 600 mm
	4 900 mm
	2 600 mm
	2 892 x 594 mm

Unidades
Units / Unités
BTS / 1200

	4 888 mm
	4 35 x 35 mm
	4 600 mm
	4 1200 mm
	2 600 mm
	2 1192 x 594 mm

Unidades
Units / Unités
BTS / 1500

	4 888 mm
	4 35 x 35 mm
	4 600 mm
	4 1500 mm
	2 600 mm
	2 1492 x 594 mm

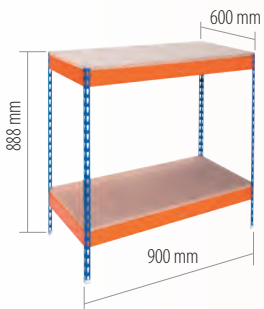

BTS 900

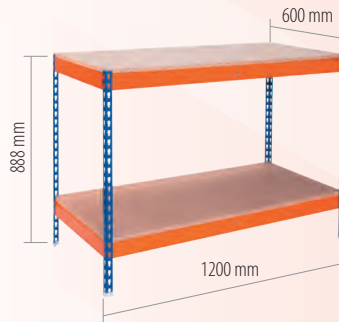



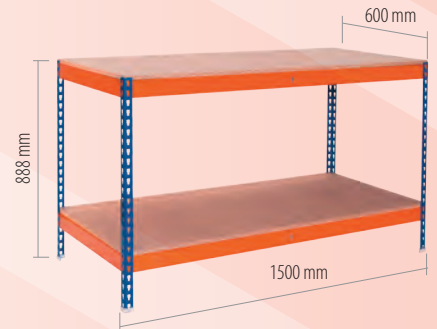

BTS 1200



BTS 1500

Configure su banco de trabajo según su necesidad
Configure your workbench as needed / Configurez votre établi de travail selon vos besoins

Perfil Upright / Montant	Fondo "L" "L" Cross beam / Lisse	Larguero "C" "C" Beam / Traverse C	Travesaño de refuerzo Deck support / Barre de renfort	Aglomerado Chipboard / Aggloméré														
 P. 42	 P. 30	 P. 30	 P. 30	 P. 31														
888	300 450 600 750 900 1000	900 1200 1500 1800 2100* 2400*	450 600 750 900 1000	<table border="1"> <thead> <tr> <th>W</th> <th>D</th> </tr> </thead> <tbody> <tr><td>892</td><td>294</td></tr> <tr><td>1192</td><td>444</td></tr> <tr><td>1492**</td><td>594</td></tr> <tr><td>1792**</td><td>744</td></tr> <tr><td>2092**</td><td>894</td></tr> <tr><td>2392**</td><td>994</td></tr> </tbody> </table>	W	D	892	294	1192	444	1492**	594	1792**	744	2092**	894	2392**	994
W	D																	
892	294																	
1192	444																	
1492**	594																	
1792**	744																	
2092**	894																	
2392**	994																	

*Necesarios 2 travesaños de refuerzo por nivel / 2 Decks support required per level / 2 Barres de renfort requis par niveau

** En 2 piezas / In 2 pieces / En 2 pièces

bancos de trabajo / work benches / bancs de travail

Artículo Item Article	Ref. Azul / Naranja Ref. Blue / Orange Réf. Bleu / Orange	€/ Unidad €/ Unit €/ Unité	Cod. EAN EAN Code Code EAN	Peso kg Weight kg Poids kg	Uds. paquete Units package Unités paquet	Dim. pakaging Dim. packaging Dim. d'emballage	Unidades palé Pallet units Unités palettes
BTP / 900	75030092	127,89	8431206750192	28,38	1	1500H x 600W x 70D	16
BTP / 1200	75030122	155,65	8431206750222	35,36	1	1500H x 600W x 70D	16
BTP / 1500	75030152	182,75	8431206750253	42,36	1	1500H x 600W x 70D	16

RAL 5010 Azul / Blue / Bleu RAL 2004 Naranja / Orange / Orange

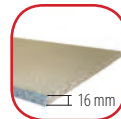
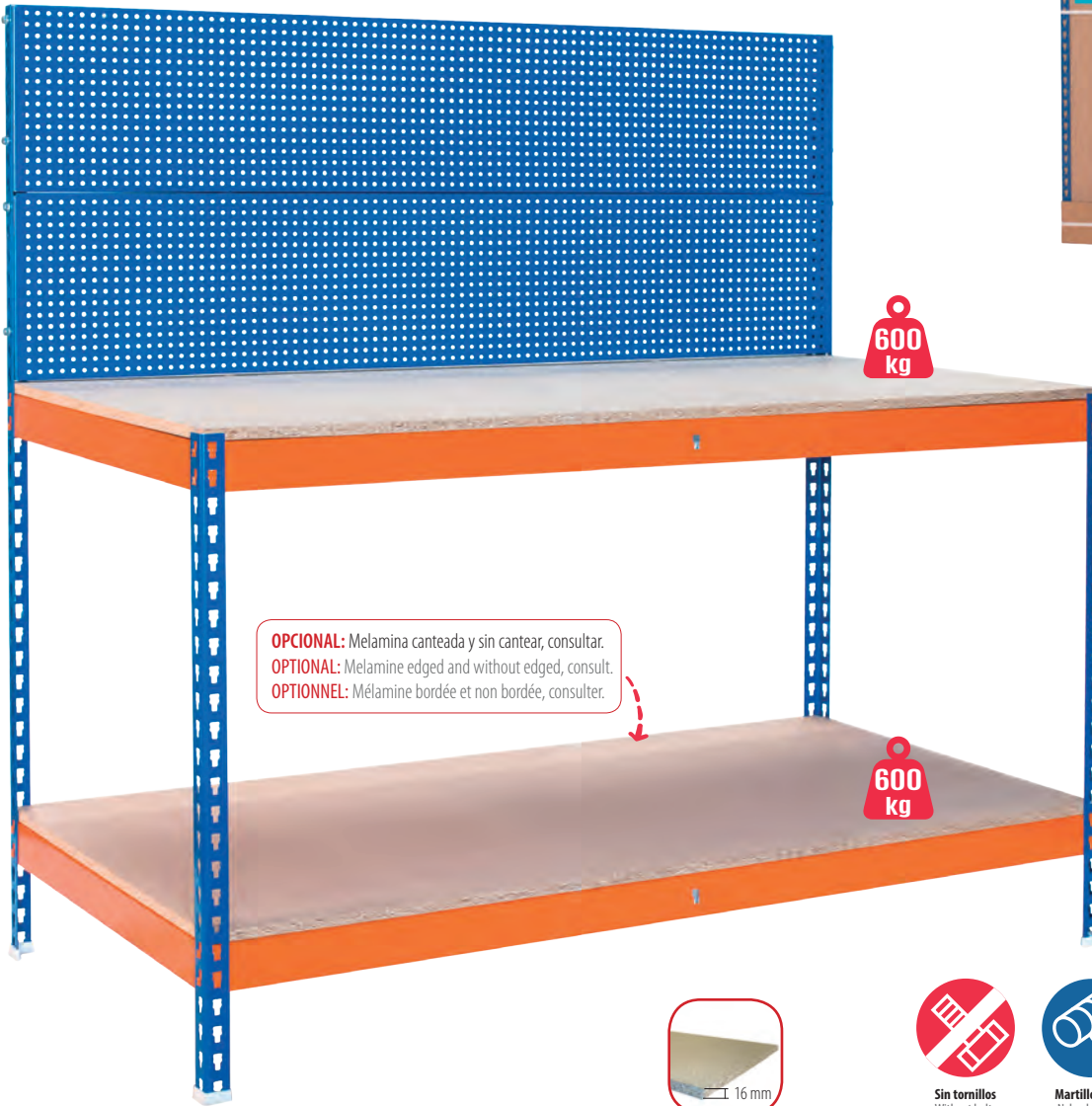

Sin tornillos
Without bolts
Sans vis



Martillo nylon
Nylon hammer
Marteau nylon



Tiempo de montaje
Assembly time
Temps d'assemblage

Instrucciones de montaje





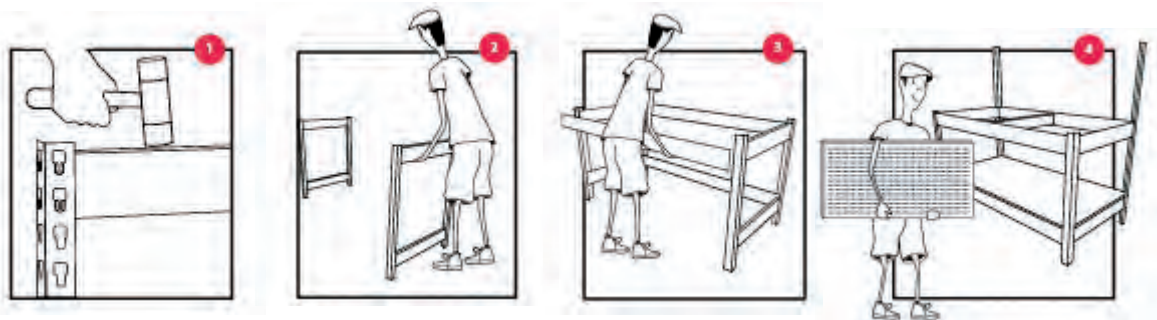

Assembly instructions

Instructions d'assemblage



Unidades Units / Unités	
BTP / 900	
	2 888 mm 2 1480 mm
	4 35 x 35 mm
	4 600 mm
	4 900 mm
	2 600 mm
	2 892 x 594 mm
	2 900 x 300 mm
	10

Unidades Units / Unités	
BTP / 1200	
	2 888 mm 2 1480 mm
	4 35 x 35 mm
	4 600 mm
	4 1200 mm
	2 600 mm
	2 1192 x 594 mm
	2 1200 x 300 mm
	10

Unidades Units / Unités	
BTP / 1500	
	2 888 mm 2 1480 mm
	4 35 x 35 mm
	4 600 mm
	4 1500 mm
	2 600 mm
	2 1492 x 594 mm
	2 1500 x 300 mm
	10

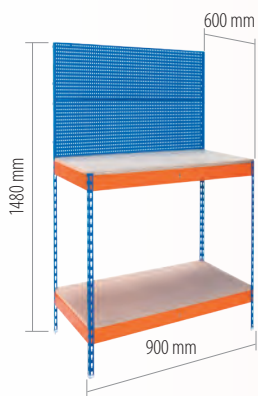

BTP 900

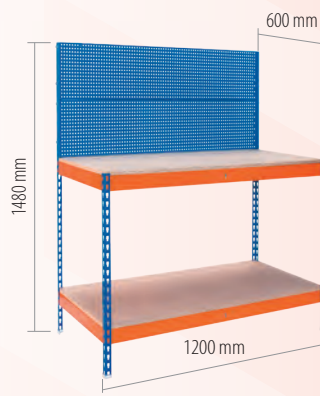



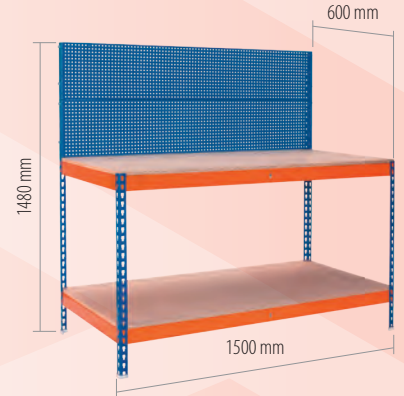



BTP 1200



BTP 1500

Configure su banco de trabajo según su necesidad

Configure your workbench as needed / Configurez votre établi de travail selon vos besoins

Perfil Upright Montant	Fondo "L" "L" Cross beam Lisse "L"	Larguero "C" "C" Beam Traverse C	Travesaño de refuerzo Deck support Barre de renfort	Aglomerado Chipboard Aggloméré	Panel Perforado Perfo panels panneaux porte-outils
					
P. 42	P. 30	P. 30	P. 30	P. 31	P. 43
888 1480	300 450 600 750 900 1000	900 1200 1500	450 600 750 900 1000 1200 1500	W D 892 1192 1492*	H W 300 900 1200 1500

* En 2 piezas / In 2 pieces / En 2 pièces

bancos de trabajo / work benches / bancs de travail

Artículo Item Article	Ref. Azul / Naranja Ref. Blue / Orange Réf. Bleu / Orange	€/ Unidad €/ Unit €/ Unité	Cod. EAN EAN Code Code EAN	Peso kg Weight kg Poids kg	Uds. paquete Units package Unités paquet	Dim. pakaging Dim. packaging Dim. d'emballage	Unidades palé Pallet units Unités palettes
BTE / 900	75030093	155,02	8431206750291	38,04	1	1500H x 750W x 70D	14
BTE / 1200	75030123	188,15	8431206750321	47,62	1	1500H x 750W x 70D	14
BTE / 1500	75030153	220,37	8431206750352	57,04	1	1500H x 750W x 70D	14

RAL 5010 Azul / Blue / Bleu RAL 2004 Naranja / Orange / Orange



OPCIONAL: Melamina canteada y sin cantear, consultar.
OPTIONAL: Melamine edged and without edged, consult.
OPTIONNEL: Mèlamine bordée et non bordée, consulter.

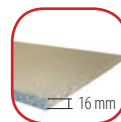

Sin tornillos
Without bolts
Sans vis



Martillo nylon
Nylon hammer
Marteau nylon



Tiempo de montaje
Assembly time
Temps d'assemblage

Instrucciones de montaje





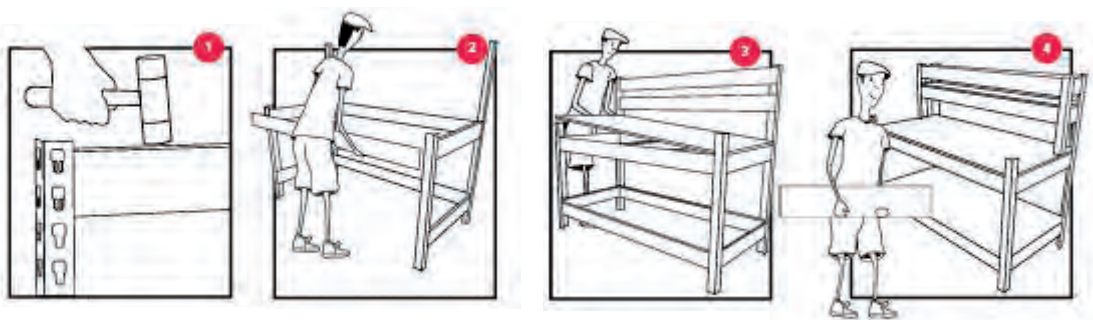

Assembly instructions

Instructions d'assemblage



Unidades
Units / Unités

BTE / 900

	2 592 mm 2 888 mm 2 1480 mm
	4 35 x 35 mm
	4 300 mm 4 750 mm
	8 900 mm
	2 750 mm
	2 892 x 294 mm 2 892 x 744 mm





Unidades
Units / Unités

BTE / 1200

	2 592 mm 2 888 mm 2 1480 mm
	4 35 x 35 mm
	4 300 mm 4 750 mm
	8 1200 mm
	2 750 mm
	2 1192 x 294 mm 2 1192 x 744 mm

Unidades
Units / Unités

BTE / 1500

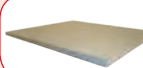
	2 592 mm 2 888 mm 2 1480 mm
	4 35 x 35 mm
	4 300 mm 4 750 mm
	8 1500 mm
	2 750 mm
	2 1492 x 294 mm 2 1492 x 744 mm



BTE 900

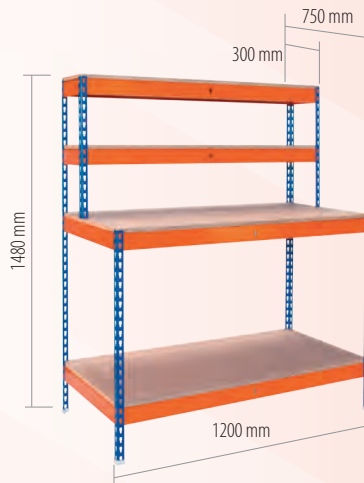



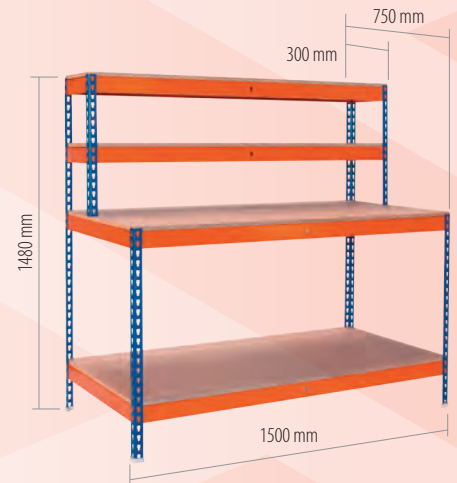

BTE 1200



BTE 1500

Configure su banco de trabajo según su necesidad
Configure your workbench as needed / Configurez votre établi de travail selon vos besoins

Perfil Upright / Montant	Fondo "L" "L" Cross beam / Lisse	Larguero "C" "C" Beam / Traverse C	Travesaño de refuerzo Deck support / Barre de renfort	Aglomerado Chipboard / Aggloméré														
 P. 42	 P. 30	 P. 30	 P. 30	 P. 31														
592 888 1480	300 450 600 750 900 1000	900 1200 1500 1800 2100* 2400*	450 600 750 900 1000	<table border="1"> <thead> <tr> <th>W</th> <th>D</th> </tr> </thead> <tbody> <tr><td>892</td><td>294</td></tr> <tr><td>1192</td><td>444</td></tr> <tr><td>1492**</td><td>594</td></tr> <tr><td>1792**</td><td>744</td></tr> <tr><td>2092**</td><td>894</td></tr> <tr><td>2392**</td><td>994</td></tr> </tbody> </table>	W	D	892	294	1192	444	1492**	594	1792**	744	2092**	894	2392**	994
W	D																	
892	294																	
1192	444																	
1492**	594																	
1792**	744																	
2092**	894																	
2392**	994																	

*Necesarios 2 travesaños de refuerzo por nivel / 2 Decks support required per level / 2 Barres de renfort requis par niveau

** En 2 piezas / In 2 pieces / En 2 pièces

J/35

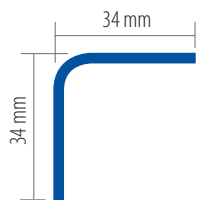
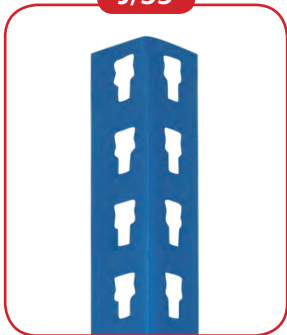

Perfiles / Uprights / Montants

Artículo L Item L Article L	Ref. Naranja Ref. Orange Réf. Orange	€/Unidad €/Unit €/Unité	Código EAN EAN Code Code EAN	Peso kg Weight kg Poids kg	Uds. Paquete Units Package Unités Paquet
J/35 de 592	73033506	1,84	8431206731023	0,44	2
J/35 de 814	73033508	2,53	8431206731047	0,58	2
J/35 de 888	73033509	2,76	8431206731054	0,66	2
J/35 de 1480	73033515	4,59	8431206731085	1,10	2

RAL 5010 Azul / Blue / Bleu



Fondos "L-I" / "L-I" Cross beams / Traverses "L-I"

Artículo L - I Item L - I Article L - I	Ref. Naranja Ref. Orange Réf. Orange	€/Unidad €/Unit €/Unité	Código EAN EAN Code Code EAN	Peso kg Weight kg Poids kg	Uds. Paquete Units Package Unités Paquet
L0300 / L - I	75045030	1,99	8431206755036	0,30	10
L0450 / L - I	75045045	2,98	8431206755043	0,45	10
L0600 / L - I	75045060	3,97	8431206755067	0,60	10
L0750 / L - I	75045075	4,96	8431206755074	0,75	10
L0900 / L - I	75045090	5,95	8431206755098	0,90	10
L1000 / L - I	75045100	6,61	8431206755104	1,00	10

RAL 2004 Naranja / Orange / Orange



Sin tornillos
Without bolts
Sans vis



Martillo nylon
Nylon hammer
Marteau nylon

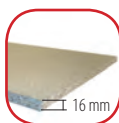

OPCIONAL: Melamina canteada y sin cantear, consultar.
OPTIONAL: Melamine edged and without edged, consult.
OPTIONNEL: Mèlamine bordée et non bordée, consulter.



P. 42

Perfiles no incluidos, necesarios para sujeción a pared
Uprights not included, necessary for wall mounting
Montants non inclus, nécessaires pour le montage mural

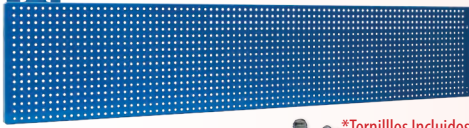

4 uds.

Paneles perforados / Perfo panels / Panneaux porte-outils

Artículo LxH Item LxP Article LxP	Ref. Azul Ref. Blue Réf. Bleu	€/Unidad €/Unit €/Unité	Código EAN EAN Code Code EAN	Peso kg Weight kg Poids kg	Uds. Paquete Units Package Unités Paquet
900 x 300	75PP030903	15,57	8431206750406	2,90	2
1200 x 300	75PP031203	20,64	8431206750413	3,79	2
1500 x 300	75PP031503	25,70	8431206750420	4,69	2

RAL 5010 Azul / Blue / Bleu

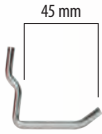

75GSC-ECO
20 uds.



75GSC-405
10 uds.

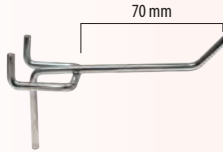

75GSC-410
10 uds.

Ganchos / Hooks / Crochets

Artículo Item Article	Referencia Referencia Referencia	€/Envase €/Pack €/Emballage	Código EAN EAN Code Code EAN	Peso kg Weight kg Poids kg	Uds. Envase Units Pack Unités de l'emballage
45 - Ø 5	75GSC-ECO	11,20	8431206750437	0,28	20
20 - Ø 4	75GSC-405	8,23	8431206750444	0,18	10
70 - Ø 4	75GSC-410	8,23	8431206750451	0,23	10

Configure su banco de trabajo según su necesidad

Configure your workbench as needed / Configurez votre établi de travail selon vos besoins

Perfil
Upright
Montant



592
888
1480

Fondo "L-I"
"L-I" Cross beam
Lisse "L-I"



300
450
600
750
900
1000

Fondo "L"
"L" Cross beam
Lisse "C"



300
450
600
750
900
1000

Larguero "C"
"C" Beam
Traverse "C"



900
1200
1500
1800
2100*
2400*

Travesaño de refuerzo
Deck support
Barre de renfort



450
600
750
900
1000
1200
1500

Aglomerado
Chipboard
Aggloméré

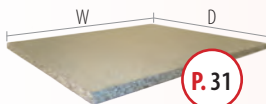

W	D
892	294
1192	444
1492**	594
1792**	744
2092**	894
2392**	944

Paneles perforados
Perfo Panels
Panneaux porte-outils

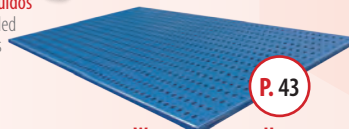

W	H
900	300
1200	
1500	

Ganchos
Hooks
Crochets

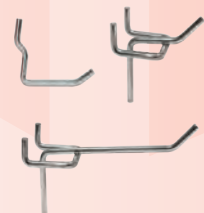

P. 43

*Necesarios 2 travesaños de refuerzo por nivel / 2 Decks support required per level / 2 Barres de renfort requis par niveau

**En 2 piezas / In 2 pieces / En 2 pièces

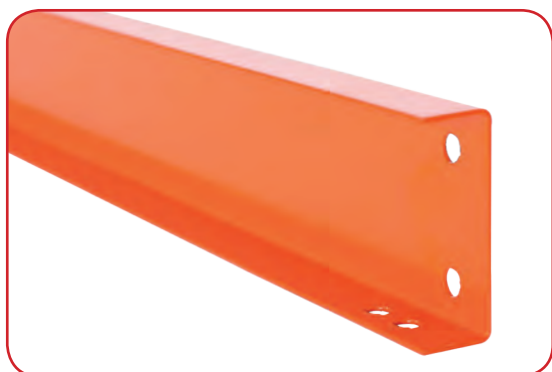

Fondos y largueros "R"

Beams and Cross beams "R" / Traverses et Lisses "R"

Artículo L Item L Article L	Ref. Naranja Ref. Orange Réf. Orange	€/Unidad €/Unit €/Unité	Código EAN EAN Code Code EAN	Peso kg Weight kg Poids kg	Uds. Paquete Units Package Unités Paquet
L0220 / R	75046030	2,50	8431206756033	0,28	2
L0370 / R	75046045	3,65	8431206756040	0,48	2
L0520 / R	75046060	4,80	8431206756064	0,67	2
L0670 / R	75046075	5,95	8431206756071	0,86	2
L0820 / R	75046090	7,10	8431206756095	1,05	2
L0920 / R	75046100	7,87	8431206756101	1,18	2
L1120 / R	75046120	9,40	8431206756125	1,44	2
L1420 / R	75046150	11,70	8431206756156	1,84	2
L1720 / R	75046180	14,00	8431206756187	2,65	2
L2020 / R	75046210	16,30	8431206756217	3,11	2
L2320 / R	75046240	18,60	8431206756248	3,57	2

RAL 2004 Naranja / Orange / Orange

Rueda y adaptador / Wheel and adapter / roue et adaptateur

Artículo L Item L Article L	Ref. Naranja Ref. Orange Réf. Orange	€/Unidad €/Unit €/Unité	Código EAN EAN Code Code EAN	Peso kg Weight kg Poids kg	Uds. Paquete Units Package Unités Paquet
Adaptador Rueda	75000036	14,29	8431206750369	0,24	4
Rueda 60 NYL	75000037	21,50	8431206750376	0,56	2
Rueda 60 FA NYL	75000038	35,30	8431206750383	0,63	2

Carga máxima: 100 kg por rueda / Maximum load: 100 kg per wheel / Charge maximale: 100 kg par roue







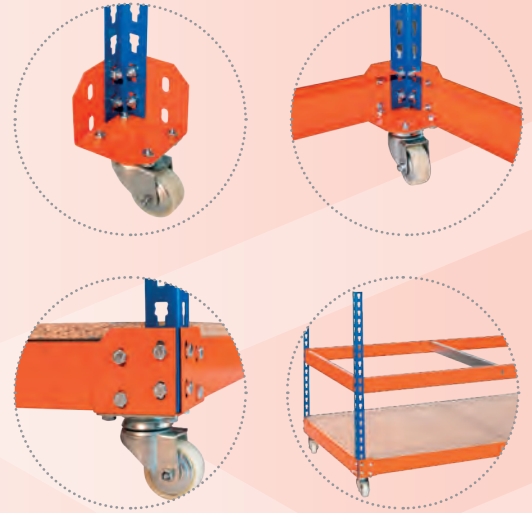



OPCIONAL: Melamina canteada y sin cantear, consultar.
OPTIONAL: Melamine edged and without edged, consult.
OPTIONNEL: Mélangine bordée et non bordée, consulter.





Configure su banco de trabajo según su necesidad
Configure your workbench as needed / Configurez votre établi de travail selon vos besoins

<p>Perfil Upright Montant</p> <p>P. 42</p>  <p>814</p>	<p>Adaptador ruedas Wheel adapter Adaptateur de roue</p> <p>P. 44</p> 	<p>Ruedas wheels roues</p> <p>P. 44</p> 	<p>Fondo "R" "R" Cross beam Lisse "R"</p> <p>P. 44</p>  <table border="0"> <tr><td>220</td></tr> <tr><td>370</td></tr> <tr><td>520</td></tr> <tr><td>670</td></tr> <tr><td>820</td></tr> <tr><td>920</td></tr> </table>	220	370	520	670	820	920	<p>Larguero "R" "R" Beam Traverse "R"</p> <p>P. 44</p>  <table border="0"> <tr><td>820</td></tr> <tr><td>1120</td></tr> <tr><td>1420</td></tr> <tr><td>1720</td></tr> <tr><td>2020*</td></tr> <tr><td>2320*</td></tr> </table>	820	1120	1420	1720	2020*	2320*																		
220																																		
370																																		
520																																		
670																																		
820																																		
920																																		
820																																		
1120																																		
1420																																		
1720																																		
2020*																																		
2320*																																		
<p>Fondo "L" "L" Cross beam Lisse "C"</p> <p>P. 30</p>  <table border="0"> <tr><td>300</td></tr> <tr><td>450</td></tr> <tr><td>600</td></tr> <tr><td>750</td></tr> <tr><td>900</td></tr> <tr><td>1000</td></tr> </table>	300	450	600	750	900	1000	<p>Larguero "C" "C" Beam Traverse "C"</p> <p>P. 30</p>  <table border="0"> <tr><td>900</td></tr> <tr><td>1200</td></tr> <tr><td>1500</td></tr> <tr><td>1800</td></tr> <tr><td>2100*</td></tr> <tr><td>2400*</td></tr> </table>	900	1200	1500	1800	2100*	2400*	<p>Travesaño de refuerzo Deck support Barre de renfort</p> <p>P. 30</p>  <table border="0"> <tr><td>450</td></tr> <tr><td>600</td></tr> <tr><td>750</td></tr> <tr><td>900</td></tr> <tr><td>1000</td></tr> </table>	450	600	750	900	1000	<p>Aglomerado Chipboard Aggloméré</p> <p>P. 31</p>  <table border="0"> <thead> <tr> <th>W</th> <th>D</th> </tr> </thead> <tbody> <tr><td>892</td><td>294</td></tr> <tr><td>1192</td><td>444</td></tr> <tr><td>1492**</td><td>594</td></tr> <tr><td>1792**</td><td>744</td></tr> <tr><td>2092**</td><td>894</td></tr> <tr><td>2392**</td><td>944</td></tr> </tbody> </table>	W	D	892	294	1192	444	1492**	594	1792**	744	2092**	894	2392**	944
300																																		
450																																		
600																																		
750																																		
900																																		
1000																																		
900																																		
1200																																		
1500																																		
1800																																		
2100*																																		
2400*																																		
450																																		
600																																		
750																																		
900																																		
1000																																		
W	D																																	
892	294																																	
1192	444																																	
1492**	594																																	
1792**	744																																	
2092**	894																																	
2392**	944																																	

*Necesarios 2 travesaños de refuerzo por nivel / 2 Decks support required per level / 2 Barres de renfort requis par niveau
**En 2 piezas / In 2 pieces / En 2 pièces